



## VX - 3 Series Salt Chlorinator

# INSTALLATION AND OPERATING INSTRUCTIONS



Melbourne: 03 8796 8600  
Sydney Nth: 02 9853 2100  
Brisbane: 07 3308 5400

Gold Coast: 07 5552 2600  
Sydney Sth: 02 8778 9500  
Adelaide: 08 8152 7600

Perth: 08 9350 2600  
Townsville: 07 4796 0100  
[www.astralpool.com.au](http://www.astralpool.com.au)  
[sales@astralpool.com.au](mailto:sales@astralpool.com.au)

A division of  
**FLUIDRA**  
The Fluidra logo graphic consists of three overlapping circles in blue, green, and yellow.

# INDEX

---

General Overview.....	3
Control Box Installation .....	3
Cell Installation .....	4
Pool Preparation.....	5
User Panel ( T Model ) .....	5
User Panel ( S Model ).....	6
Programming (T Model Only).....	7
Chlorine Output.....	7
User Mode .....	9
Warnings Display .....	10
Chlorine output level.....	10
Safety Back Wash .....	11
Run Dry Safety Feature .....	11
General Operation/Pool Chemistry.....	12
Setting the right Chlorine Output and Filtration Time. ....	12
Summer.....	12
Winter.....	12
Checking Chlorine Level.....	12
Stabiliser.....	12
pH Level.....	12
Total Alkalinity.....	12
Salt Level.....	12
Chlorinator Maintenance and Troubleshooting .....	13
Cell Maintenance.....	13
Troubleshooting. ( T Model ).....	15
Troubleshooting ( S Model ).....	16
Warranty.....	17

## GENERAL OVERVIEW

---

Congratulations! You have purchased an AstralPool VX series Chlorinator. Please read the instructions carefully and your purchase will provide you with years of trouble free use.

Your AstralPool VX Chlorinator works by converting some of the salt in your pool into chlorine which starts to destroy algae, bacteria and viruses in your pool water thereby sanitising your pool. As part of the process, the chlorine is converted back into salt and hence salt is not consumed.

Your VX Chlorinator control has many features to ensure simple operation of your chlorinator and filtration system. It has a clever Spa mode to ensure that the right level of chlorine is produced whilst you are enjoying a spa.

The VX "T" Series chlorinator has an internal electronic time clock designed to operate the filtration pump up to 4 time periods Monday to Friday and 4 time periods Saturday/Sunday. This model should not be connected to an external time clock where power is disconnected on a regular basis. The "T" series has a battery backup which is designed only to maintain timer setting memory in the event of an infrequent and short power interruption.

The VX "S" Series chlorinator does NOT have an internal time clock and is designed specifically for connection to an external time clock or switching device. It has no internal time clock.

**Note:** The Chlorinator is not intended for use by young children or infirm persons without supervision. Please ensure that young children are supervised to ensure that they do not play with the Chlorinator.

## CHLORINATOR CONTROL INSTALLATION

---

The VX Chlorinator control has a Rating of IP24 enabling it to be installed outdoors. Regulations require that the control is not allowed to be located within 3 metres of the pool water.

The control should be installed in a well ventilated position ideally away from direct sunlight. Ensure that the unit is not located near pool chemicals as fumes may damage the control.

Included in the kit are two green masonry plugs and screws. When installing on a brick or concrete wall, use a 7mm masonry drill. Mounting Screws should be 180mm apart and located at least 1500mm above ground level. A drilling template is provided on page 6.

When installing the control on a post, first attach a flat waterproof panel at least 300mm wide by 500mm long. Make sure the control is located centrally on the panel and sits flat.

Plug the 3 pin plug into a suitable weatherproof outlet and then plug the pump into the 3 pin socket in the Chlorinator control.

**Note:** The pump current rating must not exceed 8 amps.

## CELL INSTALLATION

The chlorinator cell must be located last in the pipe work just prior to the return to the pool. If valves are installed between the Chlorinator and the pool outlet, it is essential that they cannot deadhead the pump. If the pressure in the cell exceeds 150kPa and/or the water temperature exceeds 40 degrees C, the cell may fail.

**WARNING:** Never install the cell before the pump or heater.

The cell **must** be installed with the barrel unions underneath and the cell should be horizontal. Both 40mm and 50mm fittings have been provided. Make sure that the 'o'rings are correctly fitted and the unions are done up tightly.

Direction of flow through the cell is critical – unit must be plumbed with the water entering the cell at the end closest to the terminal connections (as indicated by flow direction label mounted on cell).



**WARNING:** It is essential that pipe work and equipment do not allow gases generated from the cell to collect and build up.

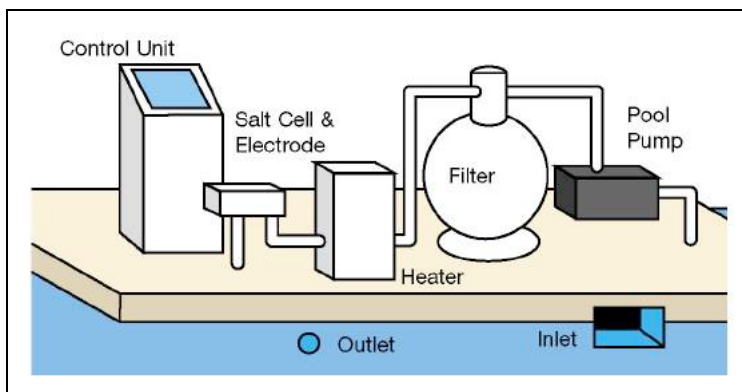

Once the cell is located, connect the black multi-core cable to the cell. The blue wire must be connected to the blue terminal. The cable is designed to come from below the cell. Make sure wing nuts are correctly tightened to ensure good contact.

## POOL PREPARATION

---

The chlorinator requires a minimum 3000ppm of salt but the recommended level is 4000ppm therefore add 4kgs of salt for every 1000 litres of water (a typical pool of around 50,000 litres requires 200kg of salt).

Salt should always be added at the shallow end of the pool and allowed to dissolve. Running the pump will mix the water and speed the dissolving process.

**WARNING:** Never add salt to the skimmer box!!

**NOTE :** Plug the pump directly into a power outlet (bypass the Chlorinator) and run for 8-10 hours to ensure the salt is dissolved prior to running the chlorinator.

When the salt is dissolved, connect the pump to the chlorinator and run it on maximum chlorine output. Check that the low salt light is not on. If it is, check again in 24 hours.

## USER PANEL (T MODEL)

---

The user panel can be broken down into 5 separate areas :

- **Programming area** for setting the clock and on periods(on T models)
- **Chlorine Output Controls** for setting the chlorine output level and to activate the Safety Backwash feature
- **Warnings display** to indicate that there is no flow to the cell or there is insufficient salt in the pool
- **User Mode** for manual control of the pump/Chlorinator or to select Spa mode.
- **Chlorine Production Level** indicates the amount of chlorine being produced.

Once programmed, you will generally only use the User Mode and Chlorine Output control.

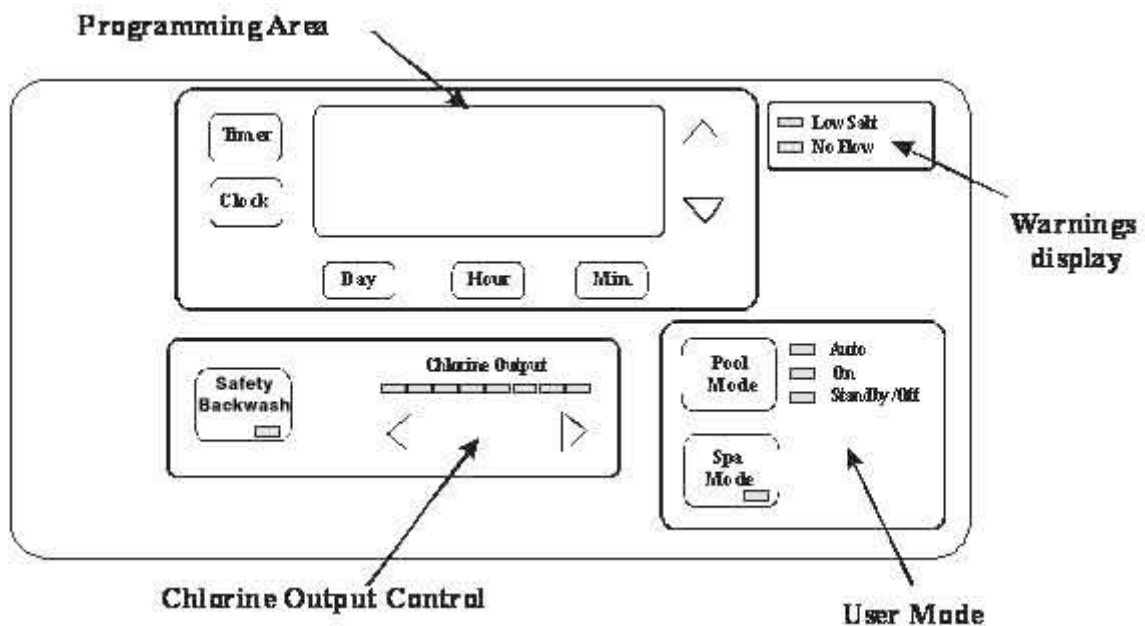

## USER PANEL (S MODEL)

---

The user panel can be broken down into 5 separate areas :

1. **Display Area**
2. **Chlorine Output Controls** for setting the chlorine output level and to activate the Safety Backwash Feature
3. **Warnings display** to indicate that there is no flow to the cell or there is insufficient salt in the pool
4. **User Mode** for manual control of the pump/Chlorinator or to select Spa mode.
5. **Chlorine Production Level** indicates the amount of chlorine being produced.

Once programmed, you will generally only use the User Mode and Chlorine Output control.

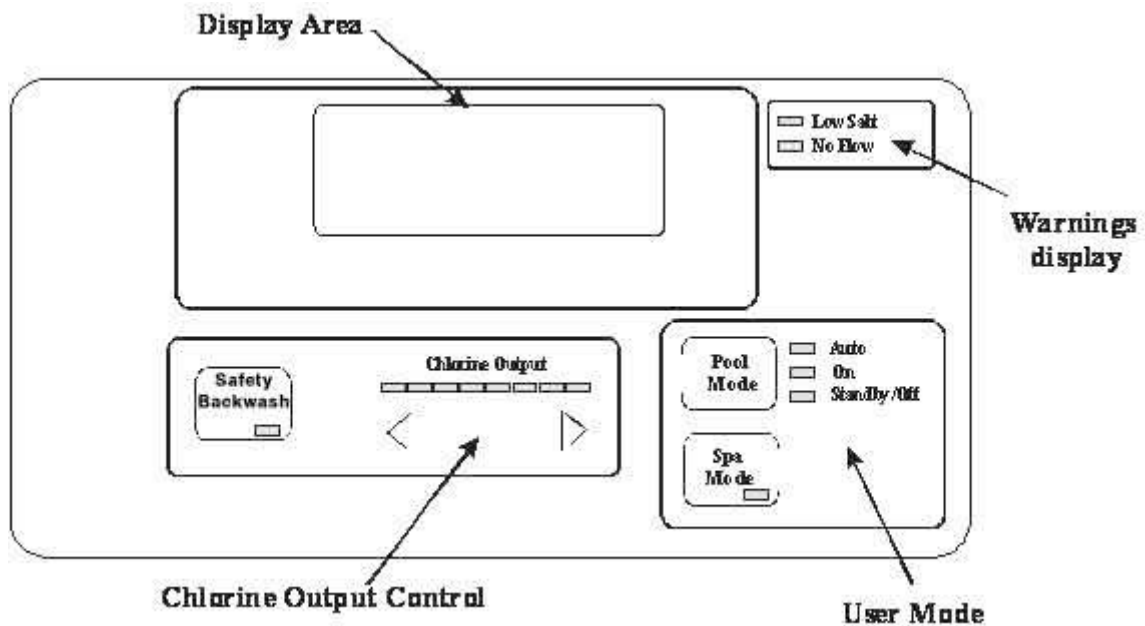

## PROGRAMMING (T MODEL ONLY)

---

### Setting Current Time/Day

Select POOL MODE Standby/Off

- (a) Press the CLOCK button
- (b) Press DAY to change the current day
- (c) Press HOUR to move the Display cursor to the hour digits and then use the Up and Down arrows to the right of the display to change the current hour
- (d) Press MIN to move the Display cursor to the min digits and then use the up and down arrows to the right of the display to change the current minutes
- (e) Press the CLOCK button to exit the clock setting mode.

### Setting Timers

Your Chlorinator has 4 timers enabling you to set four different periods in which your chlorinator/pump will operate. Different periods can be set for the weekend compared to weekdays. Timers are set by entering a start time, and a period for how long you want to operate (i.e. Mon – Fri T1 On 14:00 and Mon – Fri T1 Period 6:15 will run the chlorinator/pump during weekdays from 14:00 for 6.25 hours). To set timers, do the following:

- (f) Select **POOL MODE Standby/Off**
- (g) Press the TIMER button to step to the timer you want to set
- (h) Press DAY button to step from Mon-Fri to Sat-Sun and Visa versa
- (i) Press HOUR button to set the hour for the timer selected and use the Up/Down arrows to change the time. NOTE: Hour digits go from Not Used and then 0 to 23. If you don't want to use this timer, select Not Used.
- (j) Press MIN button to select the minutes for the timer selected and use the Up/Down arrows to change the time. Press the TIMER button to select the Period or another time and set as required.
- (k) When finished, press the TIMER button a number of times to scroll through the other times until you return to normal display. This saves your new settings.
- (l) Select **POOL MODE Auto**.

### Programming Recommendations

AstralPool recommend that you use two timers, one for the morning and one for the evening and typically for periods of 2-5 hours for each. Your chlorinator is most effective if running in the early morning or evening when it is cooler (strong sunlight consumes more chlorine). As a default, the control is set to come on at 08:00 and 16:00 both for periods of 4 hours.

NOTE: Due to different time clock settings for weekday and weekends, the timer periods cannot be set to run past midnight (24:00 hours). If you cannot adjust the start time for a timer period, it is likely the period of run time is set to go beyond 24:00 hours. To correct this, reduce the period run time first, then return to the start time and adjust.

An example of this is if you have your timer period set to run for 4 hours, the chlorinator will not allow the start time to be set any later than 19:59. If you require the chlorinator to start at 20:00 hours, the running period must be less than 4 hours to prevent cross over to the next day.

## CHLORINE OUTPUT

---

The Chlorine Output Control area of the user panel has three main functions:

- (a) Increase/Decrease arrows for setting the chlorine output level of the chlorinator. The chlorinator output can be set from levels 1 through to 8. This level only applies to Pool Mode. When the Chlorinator is in Spa mode, the chlorine output will be at level 1.
- (b) Chlorine Output display shows the level set.
- (c) The LCD display will also show an output level from 1 to 8 which indicates the performance of the chlorinator compared to the Chlorine Output LED's. Should the LCD output level (1 to 8) be less than the LED output, check salt level in pool. Should salt level be at 4000 ppm and output more than 2 settings less than LED display, your cell may need replacing.

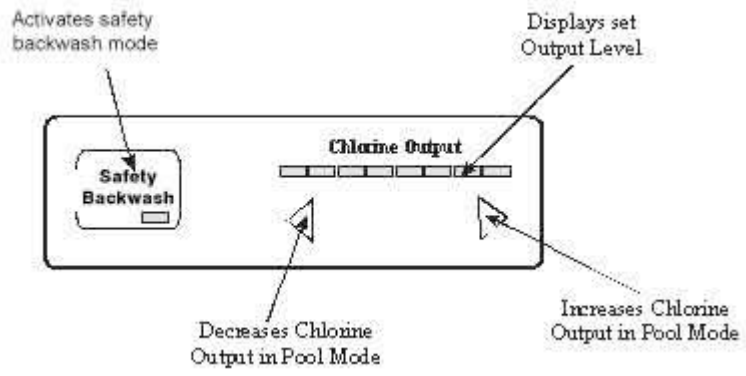



## USER MODE (T MODEL ONLY)

The user mode buttons enable you to select Pool or Spa mode and to manually control the Chlorinator/Pump. Functions are as follows:

- (a) **POOL MODE:** Sends a message to other AstralPool equipment (if fitted) to go to Pool mode. There are 3 Pool Modes
- Auto                    The Chlorinator/Pump will run according to how you have set the timers.
  - On                        The Chlorinator/Pump will run continuously.
  - Standby/Off            The Chlorinator/Pump will stay off continuously.

- (b) **SPA MODE:** Sends a message to other AstralPool equipment (if fitted) to go to Spa mode and turns the pump on

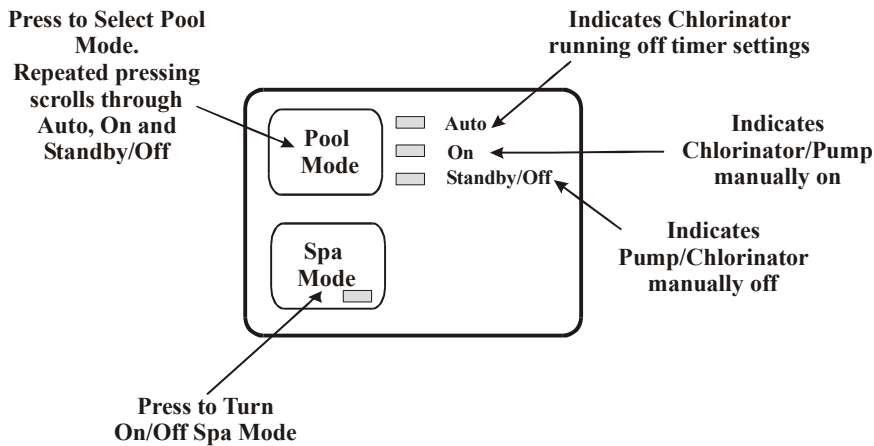

## USER MODE (S MODEL ONLY)

The user mode buttons enable you to select Pool or Spa mode and to manually control the Chlorinator/Pump. Functions are as follows:

- (c) **POOL MODE:** Sends a message to other AstralPool equipment (if fitted) to go to Pool mode.
- Auto                    Not Used
  - On                        The Chlorinator/Pump will run continuously.
  - Standby/Off            The Chlorinator/Pump will turn off.

- (d) **SPA MODE:** Sends a message to other AstralPool equipment (if fitted) to go to Spa mode and turns the pump on

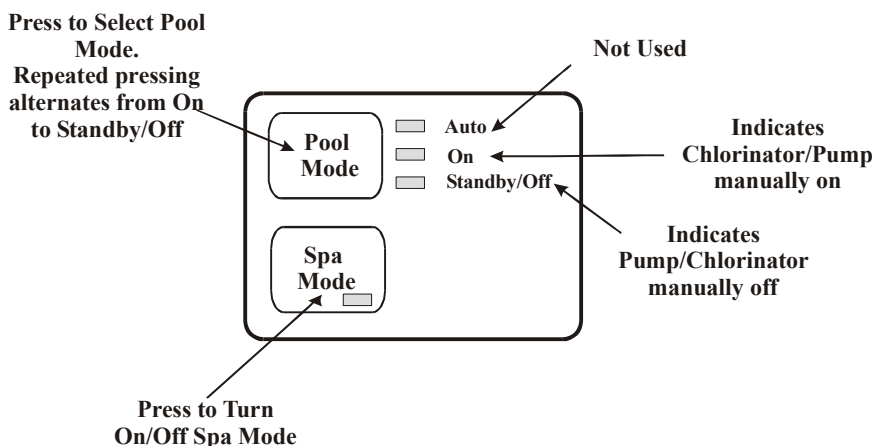

## WARNINGS DISPLAY

---

Apart from messages displayed on the User display, there are two warning indicators.

- (a) **LOW SALT:** This indicates that the concentration of salt has reduced within you pool. To rectify, add salt at approx. 50kg per 50000 litres of water (see 3.5 Salt level below)
- (b) **NO FLOW:** This indicates that the Chlorinator thinks that there is no flow to the cells. Potential problems/solutions are described in the Diagnostics section.

## CHLORINE OUTPUT LEVEL

---

The LED lights on the user panel set the desired output level or chlorine level.

As shown below, the bottom right hand corner of the LCD display indicates the actual level as distinct from the set or desired output indicated by the LED lights.

The chlorinator output, or chlorine production, will be affected by water temperature, salt levels and the input voltage of the chlorinator. When the chlorinator is operating at maximum efficiency, the Chlorine Output level should always be approximately the same level as the Set Point. The set point can be checked on the LED display which is divided into 8 sections. If all 8 LEDs are illuminated, our set point is at 8. If only 6 lights are illuminated, the set point is 6.

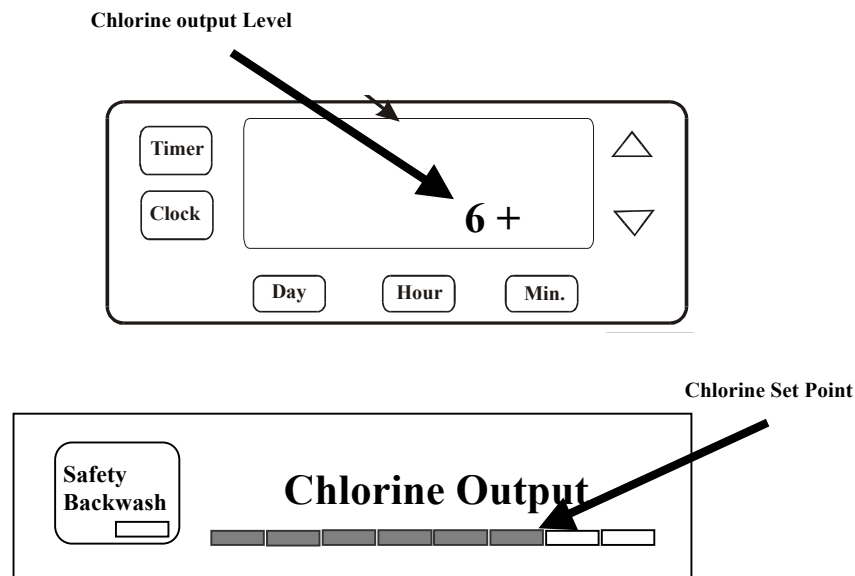

Your VX Salt chlorinator will always attempt to adjust the output so that the actual output level matches set point level. At times when the Chlorine output level is lower than the set point, check the salt level in your swimming pool at your local pool shop. Alternatively, you may have a low voltage supply to the chlorinator (less than 240Volts) or the water may be colder than usual.

Maximum efficiency will be achieved from you chlorinator at the following levels

Water at 27° C  
Voltage at 240V  
Salt Level at 4000 PPM

## **SAFETY BACKWASH**

---

When backwashing your sand filter, the pool water does not pass through the cell. During the backwash and rinse process, most chlorinators will build up potentially explosive hydrogen gas in the Chlorinator Cell.

The Safety Backwash function allows the pump to turn on without applying power to the Chlorinator Cell. This prevents the build up of hydrogen gas during the back wash and rinse process. In addition, the Safety Backwash function has set run times after which the pump will automatically turn off. This will prevent extended backwashing and potential excessive water loss from the pool.

To Back Wash and Rinse your filter follow these steps:

1. Press the pool mode button to the “off/standby” mode
2. Turn the Multiport Valve to “Backwash” position
3. Press the Safety backwash button on the user panel – the pump will now start without applying power to the chlorinator cell
  - a. Press once for one minute pump operation
  - b. Press twice for two minute pump operation
  - c. Press three times for three minute pump operation
  - d. Press four times to turn pump off
4. After pump turns off turn the filter multiport valve to Rinse
5. Press the Safety backwash button on the user panel once for a one minute rinse
6. When pump turns off, move the multiport valve back to filter position
7. Press the pool mode button to “Auto” function so that chlorinator will operate on time clock settings.

## **RUN DRY SAFETY FEATURE**

---

Your VX Chlorinator incorporates a run dry safety cut out. When the Chlorinator turns the filter pump on, it will check for water flow. If no water flow is detected within 3 minutes, the chlorinator will turn the pump off. This is designed to protect the pump seal and parts from overheating if no water flow is present.

On initial start up, you will need to prime the pump. In some cases, the pump will take more than three minutes to prime and for water flow to be detected by the chlorinator. If this should occur, simply start the pump again by pressing the Pool Mode button to “on”.

If during normal operation, the chlorinator switches the pump off after three minutes, then check the position of all valves, empty skimmer basket and pump basket and clean the filter.

**PLEASE SEE PAGE 13 FOR THE RECOMMENDED METHOD OF CELL CLEANING.**

## GENERAL OPERATION/POOL CHEMISTRY

### SETTING THE RIGHT CHLORINE OUTPUT AND FILTRATION TIME

---

Your VX Chlorinator must be run every day to ensure that your pool is correctly sanitised. As the sun dissipates chlorine, running times are higher in the summer compared to the winter. AstralPool recommend that you initially run your chlorinator at maximum output.

#### Summer

You should set your Chlorinator to operate for 8 to 10 hours per day. Ideally, run it for 4-5 hours in the morning (say 8-12pm) and 4-5 hours in the evening (say 6.00-11pm).

In extremely hot weather it may be necessary to extend the running time if you find that the free chlorine level is too low.

#### Winter

You should set your Chlorinator to operate for 6 to 8 hours per day. Again, running it in the morning and evening is preferable.

#### Checking Chlorine Level

Ideally, check your Chlorine level after the morning operating period. The free chlorine residual level should be somewhere between 1 and 3 parts per million. Increase or decrease the output of the Chlorinator to get the right residual chlorine level. It may also be necessary to adjust the operating period if you are running at minimum or maximum output.

## STABILISER

---

As previously mentioned, sunlight rapidly dissipates the amount of free chlorine in your pool. Chlorine stabiliser greatly reduces this effect.

Without stabiliser, you may need to run your Chlorinator and filtration system up to 16 hours per day longer!!!

Keep the Stabiliser reading between 30 and 60ppm.

#### pH Level

You should keep your pH level between 7.0 and 7.4 for fibreglass pools and 7.2 to 7.6 for other pools.

#### Total Alkalinity

The ideal range is between 80 and 120 ppm.

#### Salt Level

Although salt is not consumed by the Chlorinator, salt is lost during backwashing, and when your pool overflows due to rain or splashing. The correct salt level is important to cell life and the effective operation of your chlorinator. Salt level should be maintained around 4,000ppm but should never be allowed to fall below 3,000ppm.

A typical pool of around 50,000 litres requires 200kg of salt to initially set-up the pool to 4,000ppm.

A low salt level warning is indicated on your VX Chlorinator if the salt level drops. If Low Salt is indicated, check again in 24 hours and then if it is still indicated, add two 25kg bags of salt to the shallow end of your pool. Run the filtration system for approx. 6 hours to help mix the salt in the pool. It can take up to a day for the salt to fully dissolve.

If the low salt light is still on, then you should get your pool water tested. If the Salinity is above 4000ppm then you may need to have your Chlorinator checked.

**Warning:** Some people recommend that you put salt directly in the skimmer box. This is a very bad practice as it allows very high concentrations of salt to be passed through your filtration and other pool equipment.

## CHLORINATOR MAINTENANCE AND TROUBLESHOOTING

---

If the supply cord is damaged, it must be replaced by AstralPool or its service agent or a similarly qualified person in order to avoid a hazard.

### Cell Maintenance

Your VX Chlorinator has an automatic cleaning feature that under normal conditions, will keep the cell plates clear of deposits of salt and calcium.

VX Series cells have a negative charge sensor that monitors the flow and salt levels of the water. This sensor is designed to be fail safe. As it is negative charges deposits of calcium or other debris may be deposited on it and cause it to indicate a low salt or no flow condition. Should a low salt condition be indicated, have your salt level checked at your local pool shop. If the low salt condition persists, or a no flow condition is indicated when the supply pump is operating, you may need to manually clean your chlorinator Cell.

#### Cell Cleaning Instructions:

- close applicable valves
- disconnect the Chlorinator from the Mains by removing the 3 pin plug
- disconnect the cell wires
- undo the barrel nuts connecting the cell to your filtration system
- turn the cell upside down (inlet and outlet on top) and fill the cell with a mix of 1 part Hydrochloric acid to 10 parts water and leave standing for a few minutes. As an alternative, you may use an approved commercial Cell Cleaning solution
- repeat if necessary and then rinse well in clean water
- re-install the cell ensuring o-rings are correctly located and barrel nuts are tightened to prevent leaks
- re-connect cell wires with wing nuts supplied making sure the blue wire is connected to the blue terminal. Incorrect connection may damage your chlorinator control. Tighten wing-nuts to ensure the electrical connection is sound.
- Return all valves to their normal positions, re connect power to the Chlorinator and turn on at power point.

**WARNING: Follow safety instructions provided with the Hydrochloric acid or cleaning solution. When handling Hydrochloric Acid, the use of eye protection, mask and gloves are highly recommended. Extreme caution should be taken whenever handling Hydrochloric Acid or Cell Cleaning Solution.**

## Maintenance of your Chlorinator

**Maintenance Schedule:** Your new product incorporates moving parts and withstands high velocity water with chemicals in it. Some of these parts will wear in the normal course of use and require regular checks and maintenance. Performing these checks and maintenance will identify parts that have worn and require repair/replacement before further serious damage is sustained. A small amount of regular care and attention to your pool equipment will help ensure long life and trouble free performance.

Timing	Maintenance Check	Service action (if required)
Fortnightly	Check cell for calcium build up	Soak cell in mixture of 10 parts water to 1 part acid. Use a soft brush only if required
	Check water chemistry	Balance pH in pool and adjust output of unit to ensure satisfactory production of chlorine.
	Check cable connections to cell	Adjust pins by separating if not held firmly in place. Ensure no water contact is occurring with pins
Three Monthly	Check cell connections for leaks	Isolate Pump, turn power off, clean and grease O rings or replace if necessary
Six Monthly	Check chlorine levels and pump operating hours	Adjust timer and output depending on demand for current season.
	Prevent insect ingress to controller	Turn controller off, use an insect spray and spray onto walls around controller. Do not spray directly into unit.

**Important note:** Regular maintenance is important to ensure long life and trouble free performance of your pool equipment. If unable to perform the maintenance yourself, contact your local AstralPool office who will arrange a trained service technician to perform the maintenance for you.

Record your Equipment details here for quick reference:

Model No.: \_\_\_\_\_

Serial No.: \_\_\_\_\_

## TROUBLESHOOTING (T MODEL)

---

Your VX Chlorinator has diagnostic and safety features to make it easy to maintain your system. The table below summarises potential faults and their causes.

Fault Indication	Potential Cause	Remedy
No Flow	Pump turned off/disconnected or valves closed	Ensure valves/pump on
	Blue wire disconnected from cell	Connect Blue sense wire to cell
Low salt	Salt level in pool has dropped too low	See section above
	Pool water temperature is low	See section above
	Cell has calcified	See section above
	Cell has failed	Call a technician
Display blank	No Power to Controller	Plug in controller and ensure mains power available
	Fuse blown	Replace fuse (3 amp slow blow)
Low/No chlorine production	Cables not connected to cell	Connect cables
	Timer period too short	Increase timer period
	Chlorine output level too low	Increase chlorine output
	Filter needs backwashing	Backwash filter
	Ph too high	Get pH level correct
	Pool stabiliser too low	Get Stabiliser between 30 and 60 ppm
	Salt level too low	Increase salt to above 4000ppm
Clock loses time when mains power removed	Battery life expired	Call a technician

## TROUBLESHOOTING (S MODEL)

---

Your VX Chlorinator has diagnostic and safety features to make it easy to maintain your system. The table below summarises potential faults and their causes.

Fault Indication	Potential Cause	Remedy
No Flow	Pump turned off/disconnected or valves closed  Blue wire disconnected from cell	Ensure valves/pump on  Connect Blue sense wire to cell
Low salt	Salt level in pool has dropped too low  Pool water temperature is low  Cell has calcified  Cell has failed	See section above  See section above  See section above  Call a technician
Display blank	No Power to Controller   Fuse blown	Plug in controller and ensure mains power available   Replace fuse (3 amp slow blow)
Low/No chlorine production	Cables not connected to cell  Timer period too short  Chlorine output level too low  Filter needs backwashing  Ph too high  Pool stabiliser too low  Salt level too low	Connect cables  Increase timer period  Increase chlorine output  Backwash filter  Get pH level correct  Get Stabiliser between 30 and 60 ppm  Increase salt to above 4000ppm
Clock loses time when mains power removed	Battery life expired	Call a technician



## WARRANTY

---

AstralPool Australia Pty Ltd (ABN 97 007 284 504) ("AstralPool") provides the following warranty in relation to its VX – 3 Series Salt Chlorinator ("Product").

Our goods come with guarantees that cannot be excluded under the Australian Consumer Law. You are entitled to a replacement or refund for a major failure and for compensation for any other reasonably foreseeable loss or damage. You are also entitled to have the goods repaired or replaced if the goods fail to be of acceptable quality and the failure does not amount to a major failure.

The benefits of this warranty are in addition to any rights and remedies imposed by Australian State and Federal legislation that cannot be excluded. Nothing in this warranty is to be interpreted as excluding, restricting or modifying any State or Federal legislation applicable to the supply of goods and services which cannot be excluded, restricted or modified.

### WARRANTY

AstralPool warrants that, subject to the exclusions and limitations below, the Product will be free from defects in materials and workmanship during the warranty period. The warranty periods are set out below and commence 30 days after the date of purchase (to allow for installation). The warranty period may vary for different parts of the Product.

<b>Parts</b>	<b>Warranty Period</b>
Power Pack and Controller	5 years pro rata 0% payable of invoice total year 1 20% payable of invoice total year 2 40% payable of invoice total year 3 60% payable of invoice total year 4 80% payable of invoice total year 5
Chlorinator cell electrode	5 years

If a defect appears in the Product before the end of the warranty period and AstralPool finds the Product to be defective in materials or workmanship, AstralPool will, in its sole discretion, either:

- (a) replace or repair the Product or the defective part of the Product free of charge; or
- (b) Cause the Product or the defective part of the Product to be replaced or repaired by an Authorised AstralPool Service Agent free of charge.

AstralPool reserves the right to replace defective parts of the Product with parts and components of similar quality, grade and composition where an identical part or component is not available.

Goods presented for repair may be replaced by refurbished goods of the same type rather than being repaired. Refurbished parts may be used to repair the goods.

### WARRANTY CLAIMS

1. If a fault covered by warranty occurs, the customer must first contact AstralPool at the contact address listed below, or an Authorised AstralPool Service Agent.
2. Any warranty claim must be accompanied by:
  - (a) proof of purchase;
  - (b) full details of the alleged defect; and
  - (c) appropriate documentation (such as historical and maintenance records).

3. The customer must make the Product available to AstralPool or its Authorised AstralPool Service Agent for inspection and testing. AstralPool or its Authorised AstralPool Service Agent will attend the premises where the Product is installed for inspection and testing. If the Product is installed:

- (a) outside a capital city metropolitan area; and
  - (b) is not within a 20 km radius of an Authorised AstralPool Service Agent;
- then the customer may have to pay a travel fee.

4. If such inspection and testing finds no defect in the Product, the customer must pay AstralPool's usual costs of service work and testing. If such inspection and testing finds a defect that is not covered by this warranty, the customer must pay AstralPool's usual costs of service work plus any parts and labour required to repair the Product, unless recoverable from AstralPool on the failure of any statutory guarantee under the ACL.

#### Exclusions

The warranty will not apply where:

- (a) the customer is in breach of the Terms and Conditions of Sale;
- (b) the Product was used for a purpose other than one it was intended for;
- (c) the Product was repaired, modified or altered by any person other than AstralPool;
- (d) the Product has not been installed, maintained and/or operated in complete compliance with the installation and operating instructions and any instructions by AstralPool;
- (e) the Product has been subject to accident, negligence, alteration, abuse or misuse.

The warranty does not extend to:

- a) normal wear and tear;
- b) weather and other environmental conditions including but not limited to storm, flood, and/or heat wave damage; or
- c) service and maintenance items.

Examples of exclusions include but are not limited to:

- cleaning and calibration of probes

#### Commercial Installations

On commercial installations, such as health clubs, motels/hotels and hydrotherapy facilities, the warranty is limited to parts and in field labour (within capital city metropolitan areas or 20 km radius of Authorised AstralPool Service Agents) for a period of 12 months from the date of purchase plus 30 days to allow for installation.

#### LIMITATIONS

AstralPool makes no express warranties or representations other than set out in this warranty.

The repair or replacement of the Product or part of the Product is the absolute limit of AstralPool's liability under this express warranty.



**Melbourne**

39-45 Cyber Loop  
Dandenong VIC 3175  
P: 03 8796 8600

**Townsville**

17 Auscan Crescent  
Garbutt QLD 4814  
P: 07 4796 0100

**Sydney Seven Hills**

2/2 Welder Road  
Seven Hills NSW 2147  
P: 02 9853 2100

**Sydney Moorebank**

6/30 Heathcote Road  
Moorebank NSW 2170  
P: 02 8778 9500

**Adelaide**

13 William Street  
Mile End South SA 5031  
P: 08 8152 7600

**Brisbane**

1/27 Millenium Place  
Tingalpa QLD 4173  
P: 07 3308 5400

**Perth**

97 Sheffield Road  
Welshpool WA 6106  
P: 08 9350 2600

**Gold Coast**

1/28 Export Drive  
Molendinar QLD 4214  
P: 07 5552 2600

[sales@astralpool.com.au](mailto:sales@astralpool.com.au)  
[www.astralpool.com.au](http://www.astralpool.com.au)

